



Modern Custom Design by Vasco

Wooden Joineries

PRODUCT CATALOG



Welcome to
Modern Custom Design by Vasco

Thank you for taking the time to learn more
about our Company and our Products.

Not only do we manufacture our own wood mouldings, on the
premises, we also carry a wide range of products and supplies
for all your cabinet and furniture needs.

Please use our catalogue as a valuable tool
when selecting moulding for your next project.

We invite you to visit our showroom and millwork shop
at your earliest convenience. If there is something you do not see,
we will do our best to locate or manufacture the product for you.

All of us at Modern Custom Design by Vasco are looking forward
to meeting and doing business with you.

VASIL VELKOV

Tel./Fax # 954-360-0379

Cell # 954-588-8677

1580 NE 51 Court
Pompano Beach. Florida. 33064

vasco@bulgariandepot.com



Shutter Louver

Slats for louvered shutters.

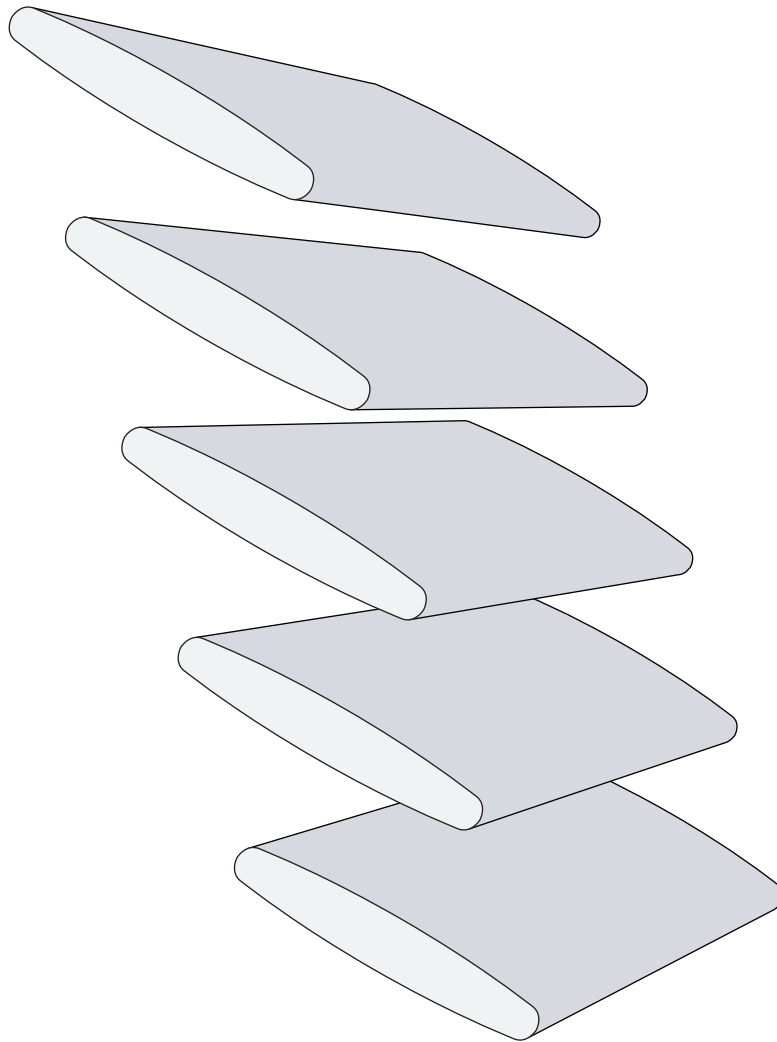

DBV 2001 Sizes: 1-1/4"
2-1/2"
3"



Cup Holder

Slats for making a wood rack for wine glasses.

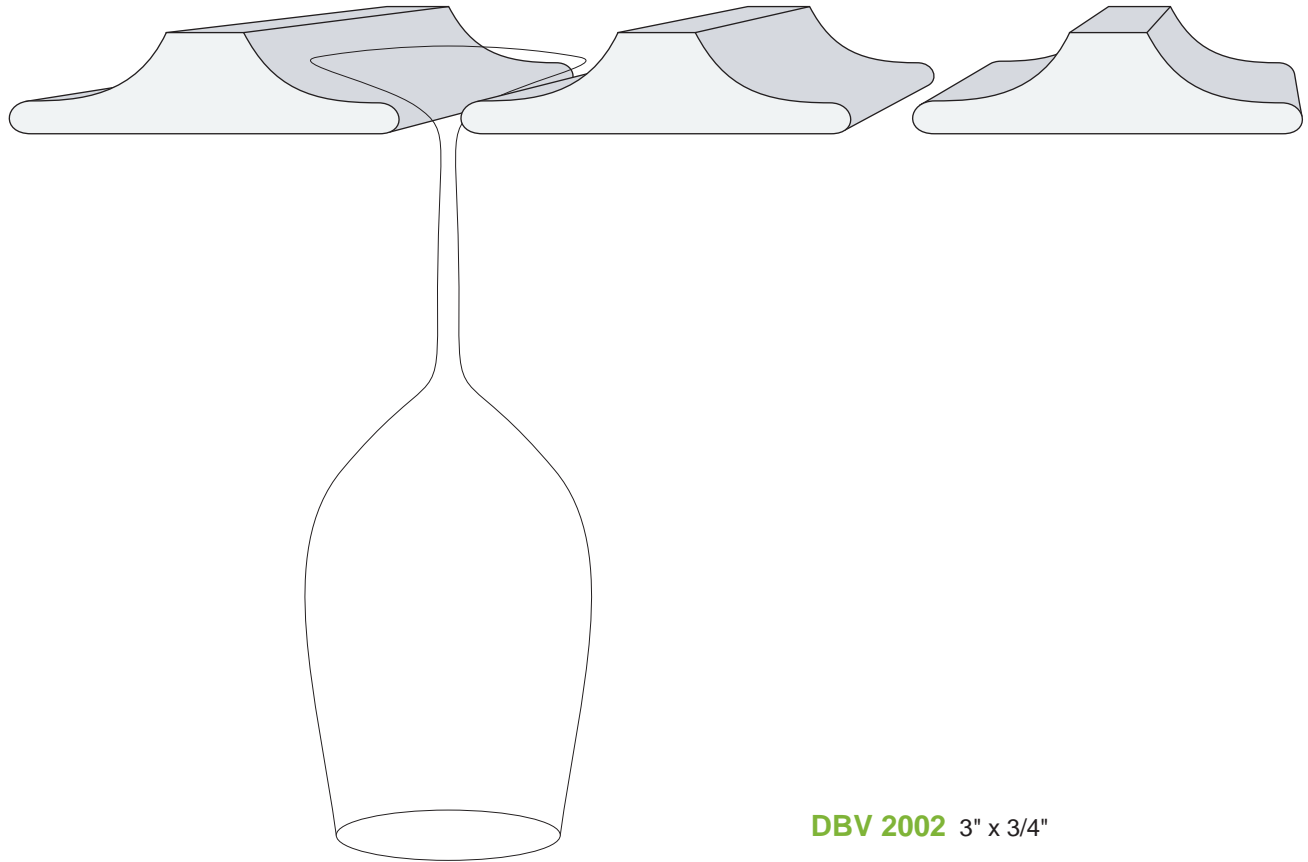

DBV 2002 3" x 3/4"



Wine Rack

A device that stores and organizes wine.

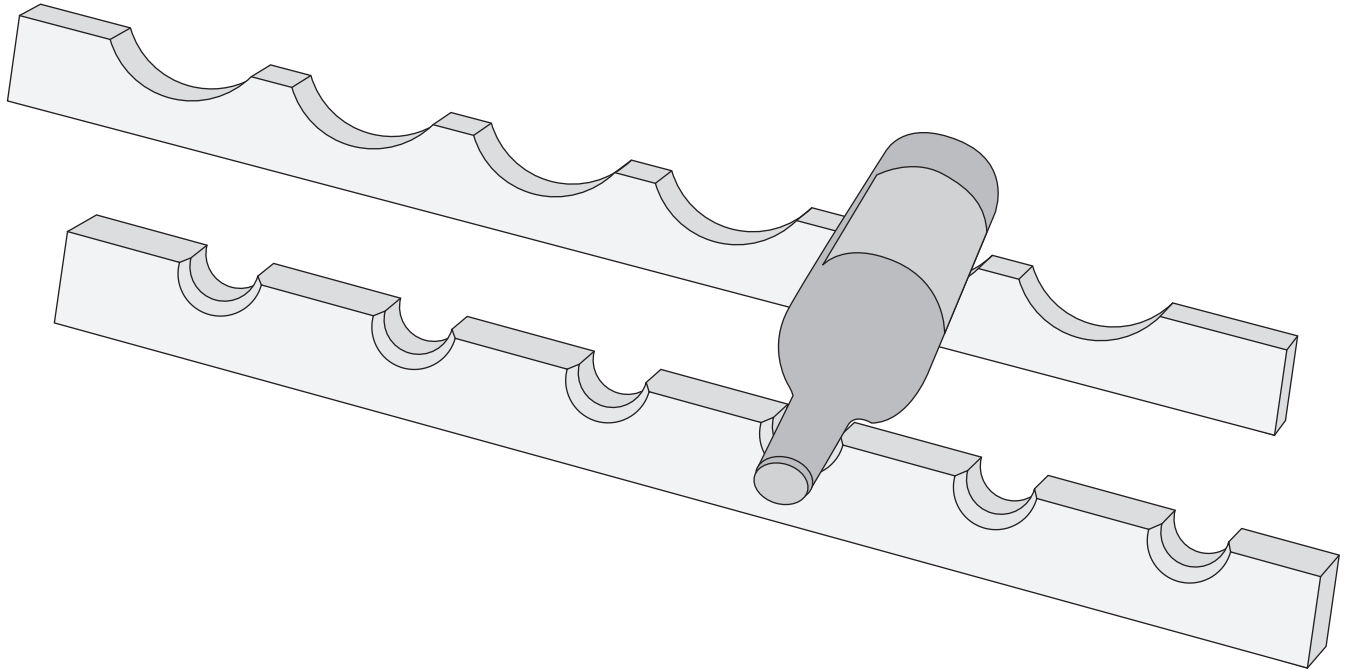

SSOGS9200MU

CHEA OMEGA S9200MUF1 MPL BOT.RCK
48"

SSOGS9200MU

CHEA OMEGA S9200MUF1 MPL BOT.RCK
24"



Wine Rack

A device that stores and organizes wine.

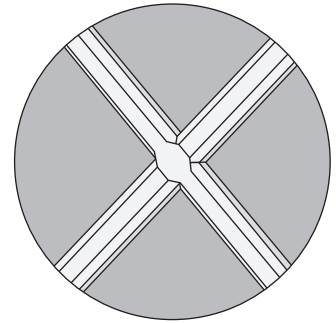
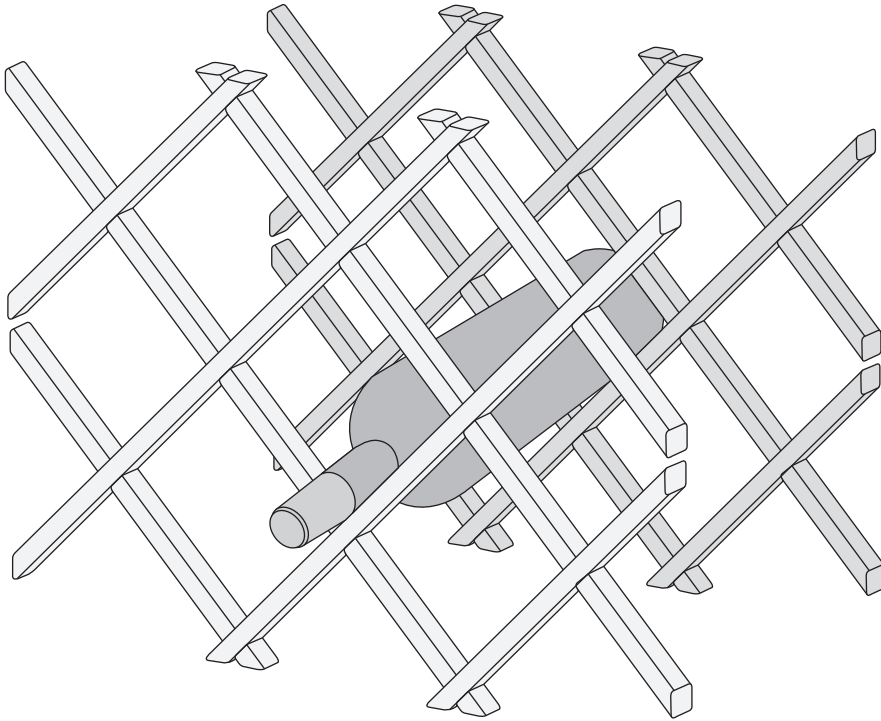

Deluxe lattice
(bevel cut)

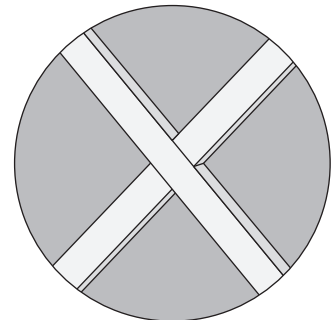
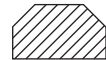

Standard lattice
(square cut)

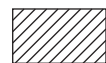

L3020MUF2CHEA	Standard Lattice	23X42
L3080MUF2CHEA	Standard Lattice	17X29
L3320MUF2CHEA	Deluxe Lattice	23X42
3380150CHEA	Standard Lattice	17X29



Rosette Holes

Different rosette holes are possible by using suitable cutters.



C 1768 Ø 2-1/2"



C 1769 Ø 2-1/2"



C 1770 Ø 2-1/2"



C 1771 Ø 2-1/2"



Rosette Holes

Different rosette holes are possible by using suitable cutters.



C 1772 Ø 2-1/2"



C 1773 Ø 2-1/2"



C 1774 Ø 2-1/2"



C 1775 Ø 2-1/2"



Rosette Holes

Different rosette holes are possible by using suitable cutters.



C 1776 Ø 2-1/2"



C 1777 Ø 2-1/2"



Possible Profiles

Display of profiles wich can be obtained using appropriate bits.

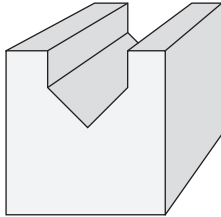

V-GROOVING BIT

1/4" 3/8" 1/2" 5/8"
+ 60° V-Grooving: 3/8"

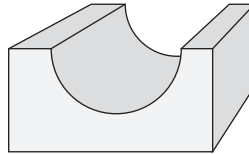

COVE BOX BIT

1/4" 3/8" 1/2" 5/8"

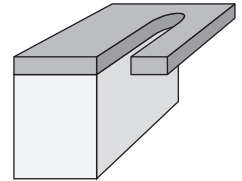

PANEL PLOT BIT

3/8"

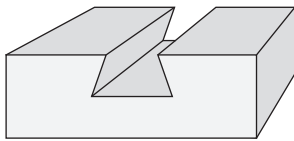

DOVETAIL BIT

1/4" 3/8" 1/2" 5/8" 3/4"

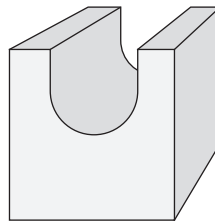

ROUND NOSE BIT

1/4" 3/8" 1/2"

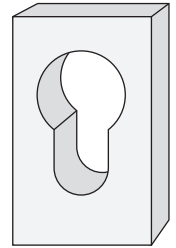

KEYHOLE BIT

3/8"

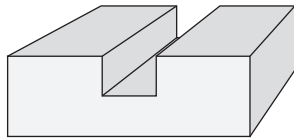

CLEANING BOTTOM BIT

3/4"

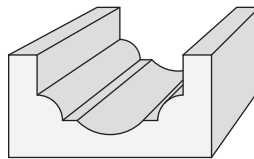

CLASSICAL PLUNGE BIT

3/4"

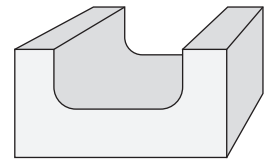

BOWL & TRAY BIT

1"



Possible Profiles

Display of profiles wich can be obtained using appropriate bits.

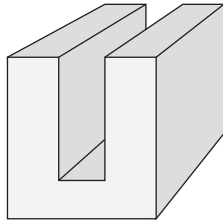

STRAIGHT BIT

5/32"

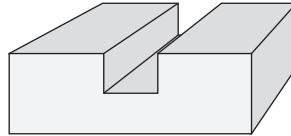

STRAIGHT BIT

3/16" 1/4" 5/16" 3/8"
7/16" 1/2" 5/8" 3/4" 1"

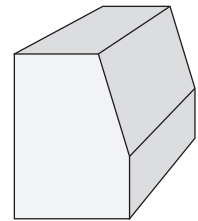

TRIMMING BIT

25°: 3/8"
30°: 1/2"

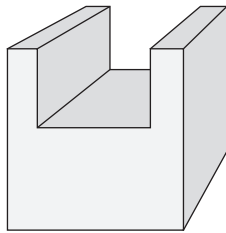

RABBETING BIT

3/8"

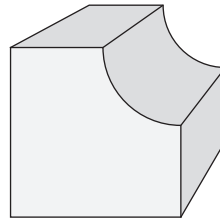

COVE BIT

1/8" 3/16" 1/4"
5/16" 3/8" 1/2"

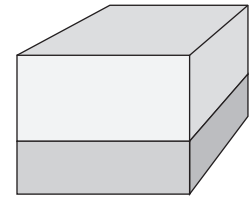

FLUSH TRIM BIT

3/8" x 1" 1/2" x 1"
3/8" x 1" (Z=3)
1/2" x 1" (Z=3)

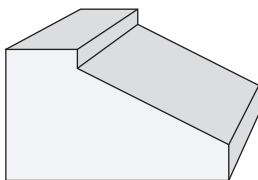

HORSE NOSE BIT

60°: 5/8"

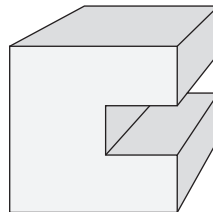

SLOT CUTTER BIT

1/4" 5/16" 3/8" 1/2"

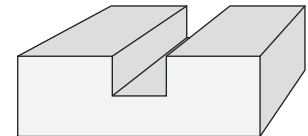

BOTTOM BIT

1/2" 5/8" 3/4"



Possible Profiles

Display of profiles wich can be obtained using appropriate bits.

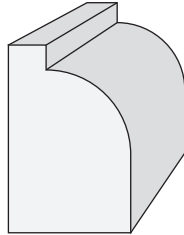

CORNER ROUND BIT

1/8" 3/16" 1/4" 5/16"
3/8" 1/2" 5/8" 3/4" 1"

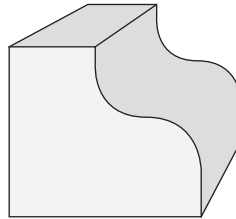

PANALLING BIT

1/2"

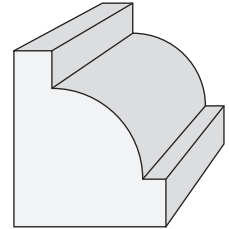

BEADING BIT

1/4" 3/8" 5/8" 3/4" 1"

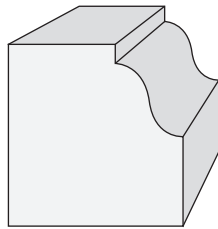

ROMAN OGEE BIT

5/16" 1/2"

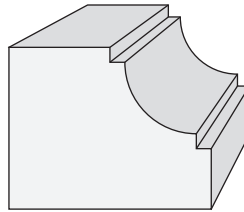

CLASSICAL COVE BIT

1/2"

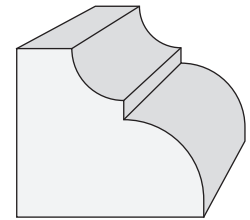

CLASSICAL BIT

1/2" 3/8"

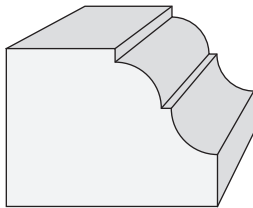

DOUBLE ROMAN BIT

1/4" 3/8"

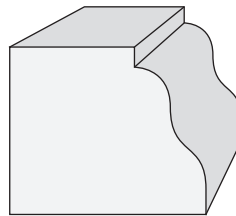

WAVE EDGE BIT

5/16"

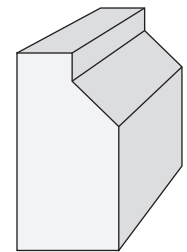

CHAMFER BIT

45°: 1/2" 30°: 5/8"
22,5°: 3/4" 15°: 7/8"